

**Large Single-Axis
Robot**

IS(P)B-WXM IS(P)B-WXMX

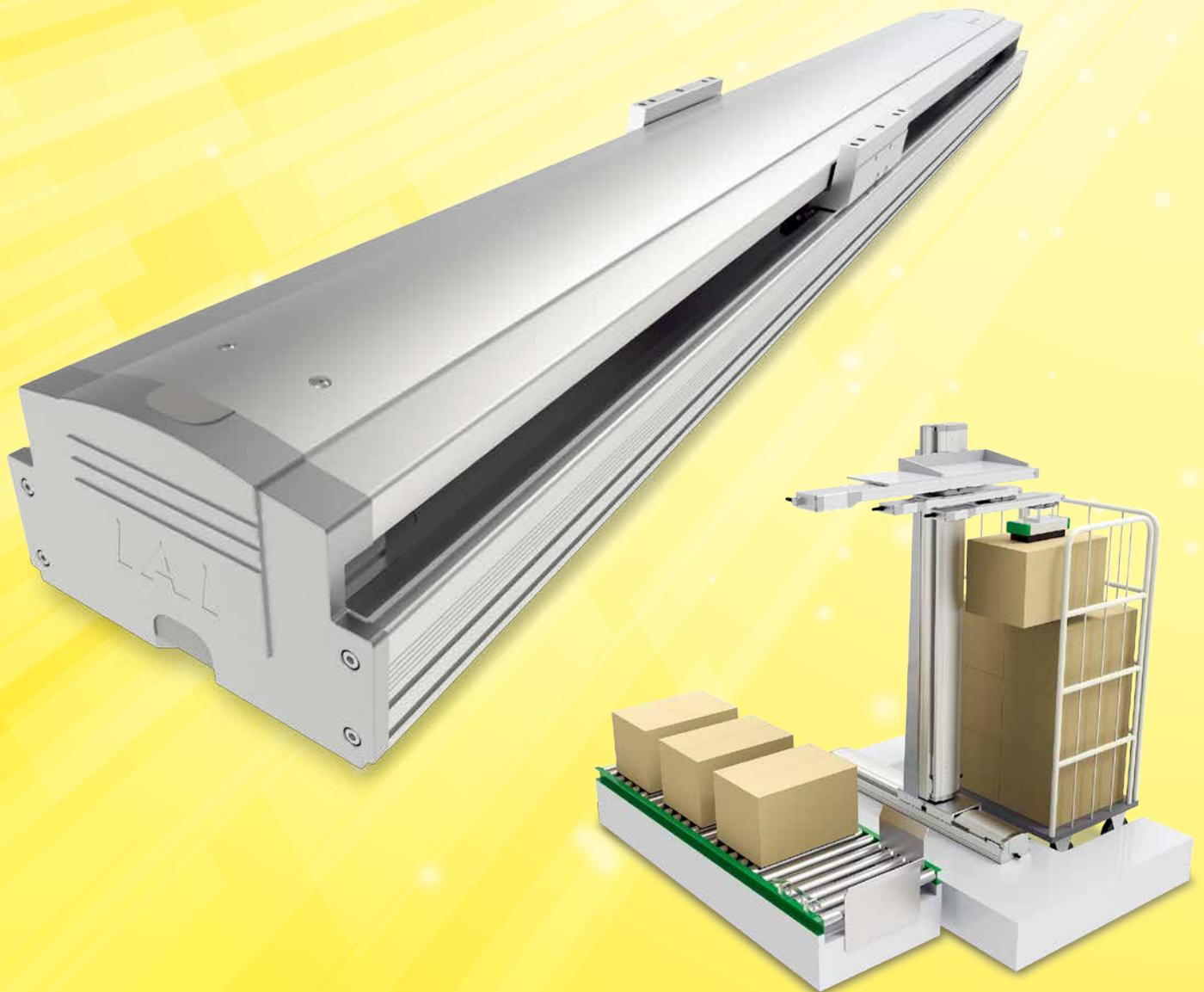

Large single-axis robots

IS(P)B-WXM/WXMX

More Powerful and Easy Operation

Suitable for high-speed and high-payload transfer

The large single-axis robot has further evolved.

(Ex) Transfer equipment for beer bottle cases

X-axis: ISB-WXMX (double slider specification)

Z-axis: ISB-WXM (double slider specification)



* Maximum values of each item

Model	Stroke	Payload	Speed	Acceleration/ deceleration
IS(P)B-WXM	1300mm	Horizontal 400kg Vertical 80kg	2500mm/s	1.2G
IS(P)B-WXMX	3000mm	Horizontal 160kg Vertical 32kg	2500mm/s	1.2G

No speed slowdown by stroke length

Increased SPEED

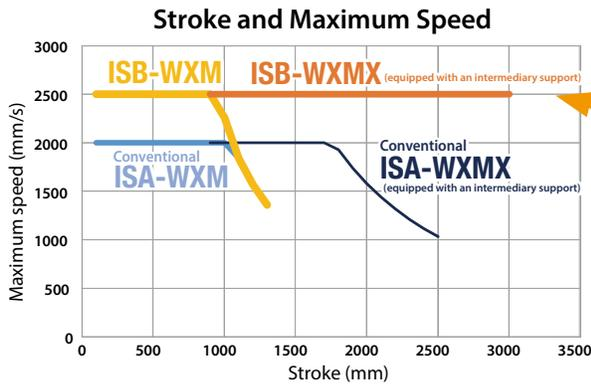

Equipped with a newly designed intermediary support.
No speed slowdown due to long stroke!



* Patent pending

Intermediary support: Suppresses deflection of the ball screw, making long-stroke and high-speed operations possible.

High payload capacity

Higher Performance

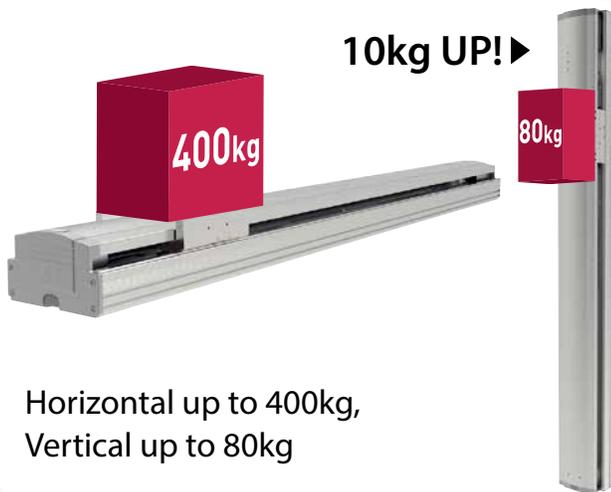

Horizontal up to 400kg,
Vertical up to 80kg

No limitations on the mount

Expanded Mounting Method

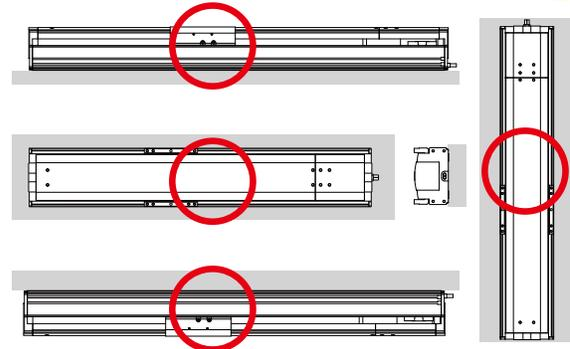

Vertical mounting is now possible for the long stroke IS(P)B-WXMX type.

Double Slider specification is selectable

Added Option

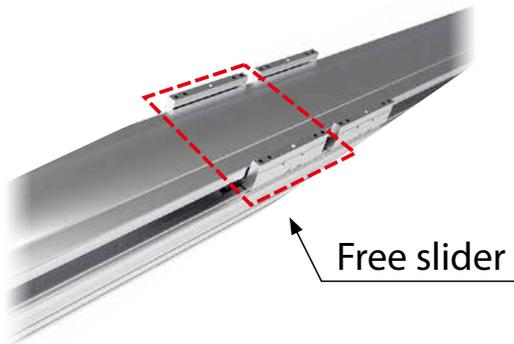

It supports larger overhang thanks to higher moment rigidity.

Easy grease replenishing

Improved Maintainability

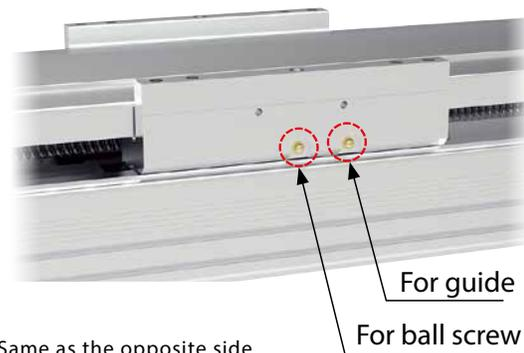

* Same as the opposite side

Grease can be replenished without removing the main unit cover and objects attached on the slider.

Model specification item

Series — Type — **WA** — **750** — Lead — Stroke — Applicable controller — Cable length — Options

Encoder type

Motor type

Lead

Stroke

Applicable controller

Cable length

Options

ISB	Standard specification
ISPB	High-precision specification

WA	Battery-less absolute
----	-----------------------

750	750W
-----	------

<IS(P)B-WXM>	
100	100mm
?	?
1300	1300mm

<IS(P)B-WXMX>	
900	900mm
?	?
3000	3000mm

(Every 50mm)

T2	SCON
	SSEL
	XSEL-P/Q
	XSEL-RA/SA
T4	RCON
	RSEL

N	No cable
S	3m
M	5m
X <input type="checkbox"/> <input type="checkbox"/>	Specified length (max. 20m)

* Robot cable
 * When ordering a cable longer than 20m up to 30m, specify "N" in the cable length of the actuator type, and separately order the cable. Refer to P. 18 for the model code to order.

A1	Cable exit from the left side
A3	Cable exit from the right side
AQ	AQ seal (standard equipment) *1
B	Brake
EB	Hanging bracket
HLA	High payload setting *2
L	Home limit switch
LM	Specify master axis
NM	Non-motor end specification
S	Specify slave axis
W	Double slider specification

*1 Make sure to specify in the option column of the model specification item.
 *2 Only the ISPB-WXM Lead 10 can be selected.

Product lineup

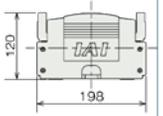
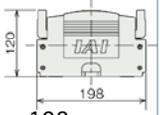
Type	Main unit width	Motor output (W)	Lead (mm)	Positioning repeatability (mm)	Stroke (mm)	Max. speed (mm/s)	Max. payload (kg)	Specification/drawing
IS(P)B	 198mm	750	50	±0.01 [±0.005]	100~1300 (every 50mm)	2500	Horizontal 80 Vertical 14	P.5~8
			25				Horizontal 160 Vertical 32	
			10				Horizontal 200 Vertical 65	
			10 (High payload setting)				Horizontal 400 Vertical 80	
IS(P)B	 198mm	750	50	±0.01 [±0.005]	900~3000 (every 50mm)	2500	Horizontal 80 Vertical 14	P.9~12
			25				Horizontal 1600 Vertical 32	

* Values in the [] are for the ISPB.

Mounting Orientation

○: possible mounting, ×: impossible mounting

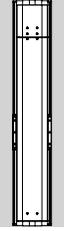
		Mounting orientation			
					
Series	Type	Horizontal, flat mount	Vertical mount	Horizontal side mount	Horizontal ceiling mount
IS(P)B	WXM	○	○*1	○ *2	○*3
	WXMx	○	○*1	×	×

*1 For vertical mounting, the motor should be on the upper side. If the motor is mounted on the bottom side, grease could be separated and the base oil flows into the motor part, causing failures of the controller, motor, and encoder. For this reason, it is not recommended that the motor be mounted on the bottom side.

*2 Oil separated from grease may flow out from the opening of the actuator's side surface. Some parts fallen from the equipment may also go into the opening of the actuator's side surface. Attach a protective part for operations as necessary.

*3 For the ceiling mount, the screw cover may sag and contact the workpiece. For 600mm stroke or longer, the workpiece and other objects must be attached apart from the slider seating surface.

Model	Stroke	Distance A
IS(P)B-WXM	Over 600mm, less than 1000mm	5mm or more
	Over 1000mm, up to 1300mm	10mm or more

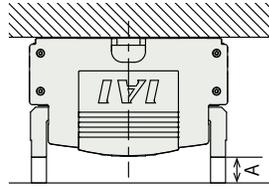

Precautions on mounting

- The flatness of the main unit mounting surface and the workpiece attaching surface should be 0.05mm/m or less. Inadequate flatness increases sliding friction, causing malfunction.
- The bottom surface and the left side (when viewed from the opposite side of the motor) of the main body base are the reference surfaces for the slider travel accuracy. When travel accuracy is needed, mount the main body using each surface as a reference.

When mounting using the side surface as reference, the surface should be machined according to the drawing below.

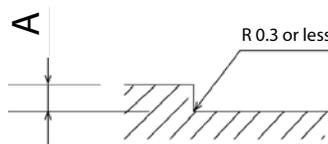
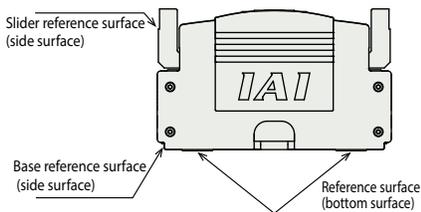

Reference surface	Dimension A (mm)
Slider reference surface (side surface)	2~9
Base reference surface (side surface)	2~5

Overhang length

This is the guideline of offset lengths for smooth operations of the actuator, when a workpiece or a bracket is mounted offset from the actuator slider. If the offset length greatly exceeds the guideline value, it may cause a failure due to vibration and the like. Use the actuator within the guideline value of the offset length.

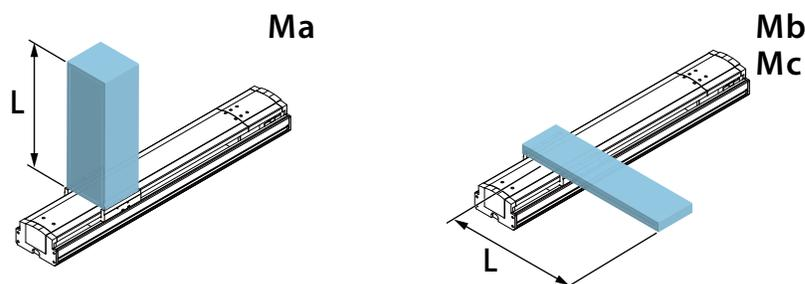

ISB-WXM-750

ISPB-WXM-750

±10μm
Standard

±5μm
High precision

Battery-less
Absolute

Body Width
200 mm

750 W

Model specification item

	WXM	WA	750				
Series	Type	Encoder type	Motor type	Lead	Stroke	Applicable controller	Cable length
ISB Standard spec. ISPB High-precision spec.		WA Battery-less absolute	750 750W	50 50mm 25 25mm 10 10mm	100 100mm ? 1300mm 1300 (every 50mm)	T2 SCON SSEL XSEL-P/Q XSEL-RA/SA T4 RCON RSEL	N No cable S 3m M 5m X□□ Specified length
							Options Refer to the option table below



Horizontal

Vertical

Side

Ceiling

Stroke	ISB	ISPB
Stroke (mm)		
100	<input type="checkbox"/>	<input type="checkbox"/>
150/200	<input type="checkbox"/>	<input type="checkbox"/>
250/300	<input type="checkbox"/>	<input type="checkbox"/>
350/400	<input type="checkbox"/>	<input type="checkbox"/>
450/500	<input type="checkbox"/>	<input type="checkbox"/>
550/600	<input type="checkbox"/>	<input type="checkbox"/>
650/700	<input type="checkbox"/>	<input type="checkbox"/>
750/800	<input type="checkbox"/>	<input type="checkbox"/>
850/900	<input type="checkbox"/>	<input type="checkbox"/>
950/1000	<input type="checkbox"/>	<input type="checkbox"/>
1050/1100	<input type="checkbox"/>	<input type="checkbox"/>
1150/1200	<input type="checkbox"/>	<input type="checkbox"/>
1250/1300	<input type="checkbox"/>	<input type="checkbox"/>

Options	Model	Ref. Page	
Type			
Cable exit from the left side	A1	P13	<input type="checkbox"/>
Cable exit from the right side	A3	P13	<input type="checkbox"/>
AQ seal (equipped standard) (Note 1)	AQ	P13	<input type="checkbox"/>
Brake	B	P13	<input type="checkbox"/>
Hanging bracket	EB	P13	<input type="checkbox"/>
High payload setting (Note 2)	HLA	P13	<input type="checkbox"/>
Home limit switch	L	P13	<input type="checkbox"/>
Specify master axis	LM	P13	<input type="checkbox"/>
Non-motor end specification	NM	P13	<input type="checkbox"/>
Specify slave axis	S	P13	<input type="checkbox"/>
Double slider specification (Note 3)	W	P13	<input type="checkbox"/>

(Note 1) Make sure to specify in the option column of the model specification item.
 (Note 2) Only the ISPB Lead 10 can be selected.
 (Note 3) When Double slider specification (W) is selected, payload, dimensions and main unit mass will change. Refer to P. 6 and P. 8 for details.

Cable Length		T2		T4	
Type	Cable code	Standard	With LS	Standard	With LS
Standard type	S (3m)	<input type="checkbox"/>	<input type="checkbox"/>	<input type="checkbox"/>	<input type="checkbox"/>
	M (5m)	<input type="checkbox"/>	<input type="checkbox"/>	<input type="checkbox"/>	<input type="checkbox"/>
Specified length	X06 (6m) ~ X10 (10m)	<input type="checkbox"/>	<input type="checkbox"/>	<input type="checkbox"/>	<input type="checkbox"/>
	X11 (11m) ~ X15 (15m)	<input type="checkbox"/>	<input type="checkbox"/>	<input type="checkbox"/>	<input type="checkbox"/>
	X16 (11m) ~ X20 (20m)	<input type="checkbox"/>	<input type="checkbox"/>	<input type="checkbox"/>	<input type="checkbox"/>

(Note) Robot cables are standard for this item.
 (Note) When using a cable longer than 20m up to 30m, specify "N" in the cable length of the actuator model, and separately order the cable. Model code for order is as follows.
 Specify the cable length in □□□. (Ex) 250=25m
 [Motor cable]
 T2 : CB-X-MA□□□□
 T4 : CB-X2-MA□□□□
 [Encoder cable]
 T2/T4 (Standard): CB-X1-PA□□□□-AWG24
 T2/T4 (with LS): CB-X1-PLA□□□□-WG24

POINT
Selection
Notes

- (1) The maximum speed decreases as the stroke becomes longer due to the dangerous number of rotation of the ball screw. Confirm the maximum speed, referring to the "Stroke and Max. Speed" of the desired stroke.
- (2) The payload specified in the "Main Specifications" shows maximum value. Refer to the "Payload Table by Speed and Acceleration/Deceleration" for details.
- (3) The guideline of usable duty ratio varies depending on the operating conditions (e.g. payload and acceleration/ deceleration). Refer to P. 15 for details.
- (4) Pay close attention to the mounting orientation. Refer to P. 4 for the overhang length.
- (5) The center of gravity of the attached object should be less than 1/2 of the overhang distance. Even when the overhang distance and load moment are within the allowable range, the operating conditions should be moderated if some abnormal vibration or noise is observed.
- (6) Guideline for the overhang length is under 900mm in the Ma, Mb, and Mc directions. (For double slider specification, slider actual span Min. [35mm]: 1975mm, Max. [180mm]: 2700mm or less) Refer to P. 4 for the overhang length.
- (7) Refer to P. 14 for ordering model of the double slider specifications and precautions.

Main specifications

Item		Details				
Lead	Ball screw lead (mm)	50	25	10	10 (high payload setting)	
	Payload	Maximum payload (kg)(Note 4)	80	160	200	100 - 400 (Note 5)
Horizontal	Speed/acceleration/deceleration	Maximum speed (mm/s)	2500	1250	600	600
		Rated acceleration/deceleration (G)	0.3	0.3	0.3	0.2
		Maximum acceleration/deceleration (G)	1.2	1.2	0.6	0.6
Vertical	Payload	Maximum payload (kg)(Note 4)	14	32	65	40 - 80 (Note 5)
		Maximum speed (mm/s)	2500	1250	600	600
		Rated acceleration/deceleration (G)	0.3	0.3	0.3	0.2
	Speed/acceleration/deceleration	Maximum acceleration/deceleration (G)	1	1	0.5	0.5
		Rated thrust (N)	255	510	1021	1021
Brake	Brake specification	Non-excited operation electromagnetic brake				
	Brake retaining force (kgf)	14	32	80	80	
Stroke	Minimum stroke (mm)	100	100	100	100	
	Maximum stroke (mm)	1300	1300	1300	1300	
	Stroke pitch (mm)	50	50	50	50	

(Note 4) When Double slider specification (W) is selected, the maximum payload will be decreased. Refer to the table below for details.

(Note 5) For stable operations, use the product with 100kg or more payload for the horizontal mount, and with 40kg or more payload for the vertical mount.

Item	Details
Driving system	Ball screw Lead 10: φ20mm, Lead 25 and 50: φ25mm Rolled C10 [C5 or equiv.]
Positioning repeatability	±0.01mm [±0.005mm]
Lost motion	0.05mm or less [0.02mm or less]
Base	Material: Aluminum white alumite treatment
Linear guide	Linear motion endlessly circulating type
Static allowable moment (Single slider specification)	Ma : 774 N·m
	Mb : 1106 N·m
	Mc : 2175 N·m
Static allowable moment (Double slider specification)(Note 6)	Ma : 3620 N·m
	Mb : 5170 N·m
	Mc : 4340 N·m
Dynamic allowable moment (Single slider specification)(Note 7)	Ma : 162 N·m
	Mb : 231 N·m
	Mc : 455 N·m
Dynamic allowable moment (Double slider specification)(Note 7)	Ma: Slider actual span Min. [35mm] 616 N·m, Max. [180mm]1130 N·m
	Mb: Slider actual span Min. [35mm] 880 N·m, Max. [180mm]1610 N·m
	Mc: Slider actual span Min. [35mm] 739 N·m, Max. [180mm]739 N·m
Ambient operating air temperature, humidity	0 - 40°C, 85%RH or less (Non-condensing)
Degree of protection	—
Vibration/shock resistance	4.9m/s ²
Overseas standards	CE marking, RoHS directive
Motor type	AC servo motor (200 V)
Encoder type	Battery-less absolute (17-bit)

(Note 6) Values remain unchanged regardless of slider span.

(Note 7) Based on the standard rated operational life of 10,000km, operational life varies according to operating and mounting conditions.

(Note) Values in brackets [] are for ISPB.

Slider type moment direction

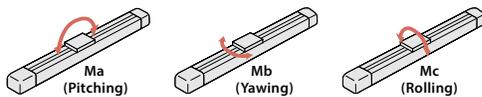

Payload by speed and acceleration

The unit for payload is kg. If blank, operation is not possible.

Orientation		Horizontal										Vertical									
Lead (mm)	Max. speed (mm/s)	Acceleration (G)										Acceleration (G)									
		0.2	0.3	0.4	0.5	0.6	0.7	0.8	0.9	1.0	1.1	1.2	0.2	0.3	0.4	0.5	0.6	0.7	0.8	0.9	1.0
50	2500	80	80	60	48	40	34	30	27	23	18	15	14	14	14	14	14	13	12	11	10
25	1250	160	160	120	96	80	68	60	54	46	36	30	29	29	29	29	29	26	24	22	20
10	600	200	200	150	120	100								65	65	60	50				
10 (High payload setting)	600	400	265	200	160	135								70	70	68	64				

Payload by speed and acceleration (Double slider specification)

The unit for payload is kg. If blank, operation is not possible.

Orientation		Horizontal										Vertical									
Lead (mm)	Max. speed (mm/s)	Acceleration (G)										Acceleration (G)									
		0.2	0.3	0.4	0.5	0.6	0.7	0.8	0.9	1.0	1.1	1.2	0.2	0.3	0.4	0.5	0.6	0.7	0.8	0.9	1.0
50	2500	70	70	50	38	30	24	20	17	14	8	5	10	10	8	6	4	3	2.5	2	1
25	1250	150	150	110	86	70	58	50	44	36	26	20	25	25	22	20	19	15	12	9	7
10	600	190	190	140	110	90							56	56	50	40					
10 (High payload setting)	600	390	255	190	150	125							70	70	58	54					

Stroke and maximum speed

Lead	Stroke	100~800 (every 50mm)	850	900	950	1000	1050	1100	1150	1200	1250	1300
			50	2500				2260		1840		1570
25	1250				1130		920		785		680	
10	600		460		380		320		270		235	

(Unit: mm/s)

Dimensions

(Note) The motor cable and encoder cable are to be connected to the cable joint connector. Refer to P.18 for the details of the cable.
 (Note) When the slider is returning to its home position, be careful of interference from surrounding objects, as it will travel until it reaches the M.E.
 (Note) The product has to be sent back to IAI for adjustments when the home direction is changed.
 (Note) The external dimensions are the same as that of the product with brake.

CAD drawings can be downloaded from our website.
www.intelligentactuator.com



ST: Stroke
 M.E: Mechanical end
 S.E: Stroke end

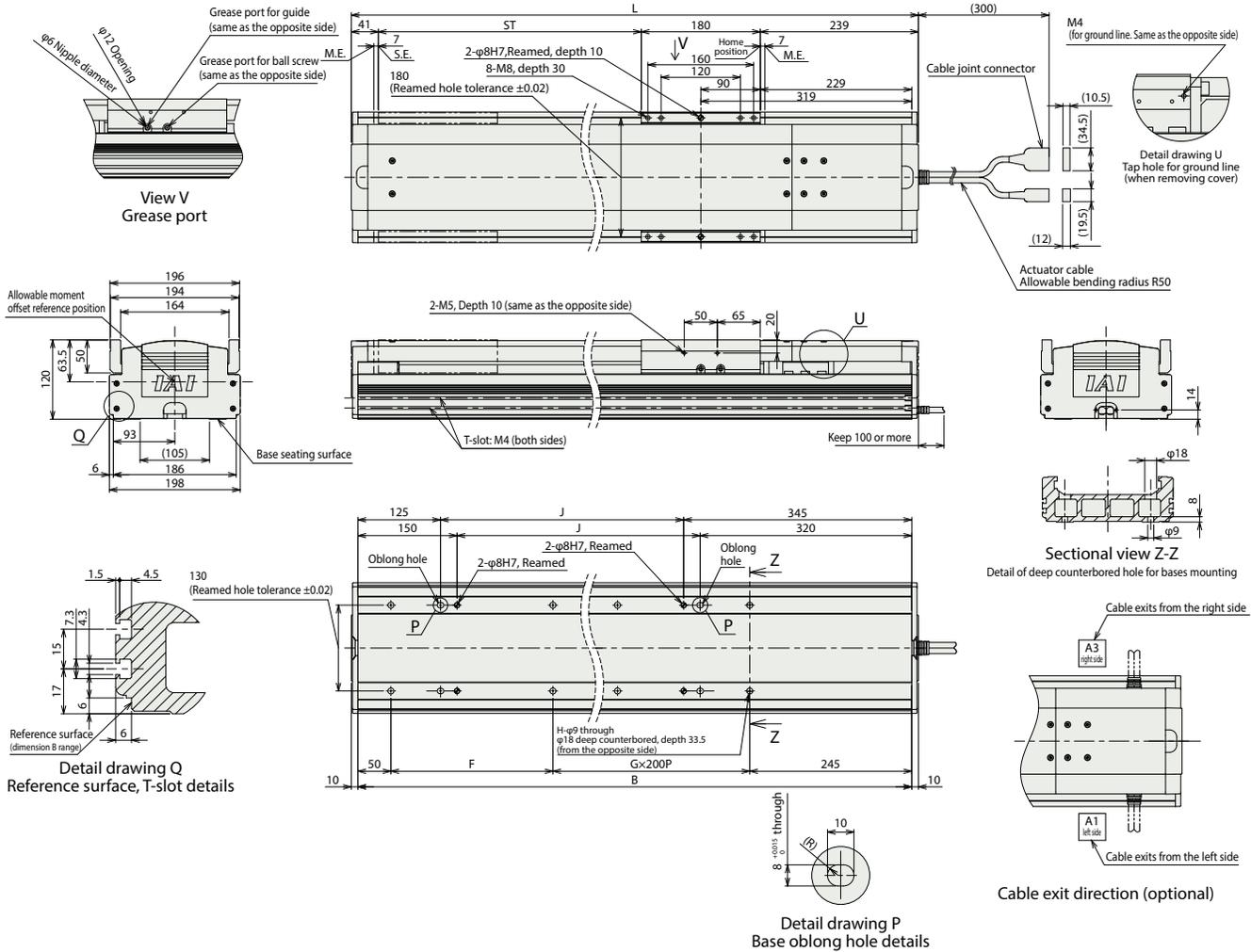

Dimensions by Stroke

Stroke	100	150	200	250	300	350	400	450	500	550	600	650	700	750	800	850	900	950	1000	1050	1100	1150	1200	1250	1300
L	560	610	660	710	760	810	860	910	960	1010	1060	1110	1160	1210	1260	1310	1360	1410	1460	1510	1560	1610	1660	1710	1760
B	540	590	640	690	740	790	840	890	940	990	1040	1090	1140	1190	1240	1290	1340	1390	1440	1490	1540	1590	1640	1690	1740
F	245	295	145	195	245	295	145	195	245	295	145	195	245	295	145	195	245	295	145	195	245	295	145	195	245
G	0	0	1	1	1	1	2	2	2	2	3	3	3	3	4	4	4	4	5	5	5	5	6	6	6
H	4	4	6	6	6	6	8	8	8	8	10	10	10	10	12	12	12	12	14	14	14	14	16	16	16
J	70	120	170	220	270	320	370	420	470	520	570	620	670	720	770	820	870	920	970	1020	1070	1120	1170	1220	1270

Mass by Stroke

Stroke	100	150	200	250	300	350	400	450	500	550	600	650	700	750	800	850	900	950	1000	1050	1100	1150	1200	1250	1300
Mass (kg) w/o brake	18.3	19.3	20.4	21.5	22.5	23.6	24.6	25.7	26.8	27.8	28.9	29.9	31.0	32.0	33.1	34.2	35.2	36.3	37.3	38.4	39.5	40.5	41.6	42.6	43.7
Mass (kg) w/brake	18.8	19.8	20.9	22.0	23.0	24.1	25.1	26.2	27.3	28.3	29.4	30.4	31.5	32.5	33.6	34.7	35.7	36.8	37.8	38.9	40.0	41.0	42.1	43.1	44.2

Dimensions (double slider specification)

(Note) The motor cable and encoder cable are to be connected to the cable joint connector. Refer to P. 18 for the details of the cable.
 (Note) When the slider is returning to its home position, be careful of interference from surrounding objects, as it will travel until it reaches the M.E.
 (Note) The product has to be sent back to IAI for adjustments when the home direction is changed.
 (Note) The external dimensions are the same as that of the product with brake.
 (Note) The drawings below show dimension for the minimum slider actual span.

CAD drawings can be downloaded from our website.
www.intelligentactuator.com



ST: Stroke
 M.E: Mechanical end
 S.E: Stroke end

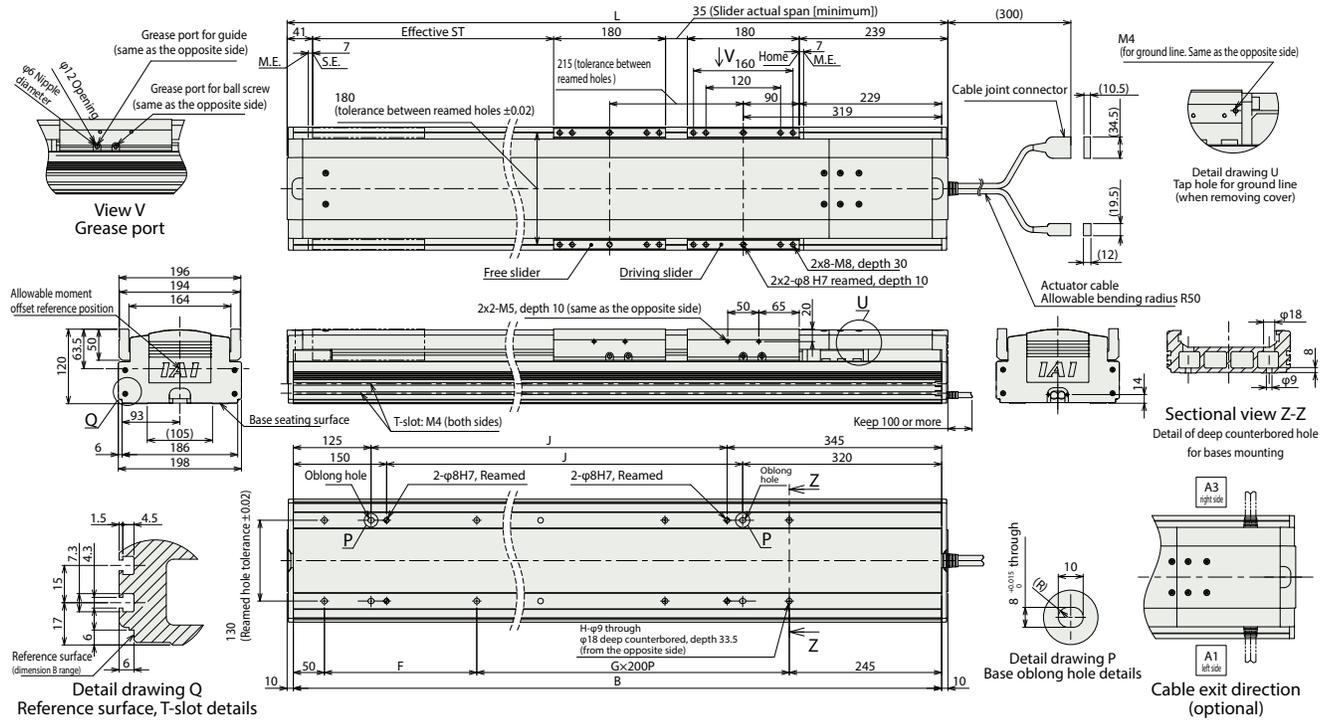

Dimensions by Stroke

Nominal stroke		350	400	450	500	550	600	650	700	750	800	850	900	950	1000	1050	1100	1150	1200	1250	1300
Effective stroke	Slider actual span minimum [35mm]	135	185	235	285	335	385	435	485	535	585	635	685	735	785	835	885	935	985	1035	1085
	Slider actual span maximum [180mm]	—	—	—	140	190	240	290	340	390	440	490	540	590	640	690	740	790	840	890	940
L		810	860	910	960	1010	1060	1110	1160	1210	1260	1310	1360	1410	1460	1510	1560	1610	1660	1710	1760
B		790	840	890	940	990	1040	1090	1140	1190	1240	1290	1340	1390	1440	1490	1540	1590	1640	1690	1740
F		295	145	195	245	295	145	195	245	295	145	195	245	295	145	195	245	295	145	195	245
G		1	2	2	2	2	3	3	3	3	4	4	4	4	5	5	5	5	6	6	6
H		6	8	8	8	8	10	10	10	10	12	12	12	12	14	14	14	14	16	16	16
J		320	370	420	470	520	570	620	670	720	770	820	870	920	970	1020	1070	1120	1170	1220	1270

(Note) Nominal stroke: Stroke used as the model code.
 Effective stroke: Stroke actually operable.

Mass by Stroke

Nominal stroke		350	400	450	500	550	600	650	700	750	800	850	900	950	1000	1050	1100	1150	1200	1250	1300
Effective stroke	Slider actual span minimum [35mm]	135	185	235	285	335	385	435	485	535	585	635	685	735	785	835	885	935	985	1035	1085
	Slider actual span maximum [180mm]	—	—	—	140	190	240	290	340	390	440	490	540	590	640	690	740	790	840	890	940
Mass (kg)	Without brake	26.6	27.6	28.7	29.8	30.8	31.9	32.9	34.0	35.0	36.1	37.2	38.2	39.3	40.3	41.4	42.5	43.5	44.6	45.6	46.7
	With brake	27.1	28.1	29.2	30.3	31.3	32.4	33.4	34.5	35.5	36.6	37.7	38.7	39.8	40.8	41.9	43.0	44.0	45.1	46.1	47.2

(Note) The free slider mass of 3kg is added to the single slider specification.

Applicable controllers

The actuator in this page can be operated by the following controllers. Select the type that suits the application of intended use.

Name	External appearance	Maximum number of connectable axes.	Power voltage	Control method																Max. number of positioning points	
				Positioner	Pulse train	Program	Network *Select												ECM		
				DV	CC	CIE	PR	CN	ML	ML3	EC	EP	PRT	SSN	ECM						
RCON		16 (8 for ML3, SSN and ECM)	DC24V Single phase AC200V Three-phase AC200V	—	—	—	●	●	●	●	—	—	●	●	●	●	●	●	●	●	128 (ML3, SSN and ECM have no positioning data)
RSEL		8	Single phase AC200V Three-phase AC200V	—	—	●	●	●	●	—	—	—	●	●	●	—	—	—	—	—	36000
SCON-CB/CG8		1	Single phase AC200V	●	●	—	●	●	●	●	●	●	●	●	●	—	●	—	—	—	512 (768 for the network specification)
SSEL-CS		2		●	—	●	●	—	—	—	—	—	—	●	—	—	—	—	—	—	20000
XSEL-P/Q		6	Single phase AC200V Three-phase AC200V	—	—	●	●	●	—	—	—	—	—	—	—	●	—	—	—	—	20000
XSEL-RA/SA		8	Single phase AC200V Three-phase AC200V	—	—	●	●	●	●	—	—	—	—	—	—	●	●	—	—	—	55000 (varies depending on the type)

ISB-WXMX-750

ISPB-WXMX-750

$\pm 10\mu\text{m}$ Standard	$\pm 5\mu\text{m}$ High precision	Battery-less Absolute	Intermediary support	Body Width 200 mm	750 W
---------------------------------	--------------------------------------	-----------------------	----------------------	----------------------	-------

Model specification item

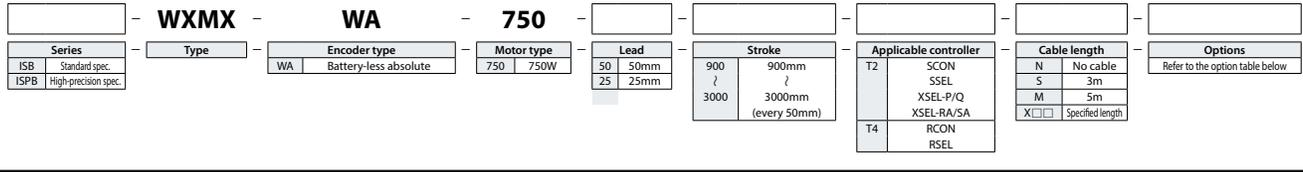

CE RoHS 10

Horizontal Vertical Side Ceiling

Stroke		
Stroke (mm)	ISB	ISPB
900	<input type="radio"/>	<input type="radio"/>
950/1,000	<input type="radio"/>	<input type="radio"/>
1050/1150	<input type="radio"/>	<input type="radio"/>
1150/1200	<input type="radio"/>	<input type="radio"/>
1250/1300	<input type="radio"/>	<input type="radio"/>
1350/1400	<input type="radio"/>	<input type="radio"/>
1450/1500	<input type="radio"/>	<input type="radio"/>
1550/1600	<input type="radio"/>	<input type="radio"/>
1650/1700	<input type="radio"/>	<input type="radio"/>
1750/1800	<input type="radio"/>	<input type="radio"/>
1850/1900	<input type="radio"/>	<input type="radio"/>
1950/2000	<input type="radio"/>	<input type="radio"/>
2050/2100	<input type="radio"/>	<input type="radio"/>
2150/2200	<input type="radio"/>	<input type="radio"/>
2250/2300	<input type="radio"/>	<input type="radio"/>
2350/2400	<input type="radio"/>	<input type="radio"/>
2450/2500	<input type="radio"/>	<input type="radio"/>
2550/2600	<input type="radio"/>	<input type="radio"/>
2650/2700	<input type="radio"/>	<input type="radio"/>
2750/2800	<input type="radio"/>	<input type="radio"/>
2850/2900	<input type="radio"/>	<input type="radio"/>
2950/3000	<input type="radio"/>	<input type="radio"/>

POINT Selection Notes

- The payload specified in the "Main Specifications" shows maximum value. Refer to the "Payload Table by Speed and Acceleration/Deceleration" for details.
- The guideline of usable duty ratio varies depending on the operating conditions (e.g. payload and acceleration/deceleration). Refer to P. 15 for details.
- Pay close attention to the mounting orientation. Refer to P. 4 for the overhang length.
- The center of gravity of the attached object should be less than 1/2 of the overhang distance. Even when the overhang distance and load moment are within the allowable range, the operating conditions should be moderated if some abnormal vibration or noise is observed.
- Guideline for the overhang length is under 900mm in the Ma, Mb, and Mc directions. (For double slider specification, slider actual span Min. [35mm]: 1975mm, Max. [180mm]: 2700mm or less) Refer to P. 4 for the overhang length.
- Refer to P. 14 for ordering model of the double slider specifications and precautions.

Options			
Type	Model	Ref. Page	
Cable exit from the left side	A1	P13	<input type="radio"/>
Cable exit from the right side	A3	P13	<input type="radio"/>
AQ seal (equipped standard) (Note 1)	AQ	P13	<input type="radio"/>
Brake	B	P13	<input type="radio"/>
Hanging bracket	EB	P13	<input type="radio"/>
Home limit switch	L	P13	<input type="radio"/>
Specify master axis	LM	P13	<input type="radio"/>
Non-motor end specification	NM	P13	<input type="radio"/>
Specify slave axis	S	P13	<input type="radio"/>
Double slider specification (Note 2)	W	P13	<input type="radio"/>

(Note 1) Make sure to specify in the option column of the model specification item.
 (Note 2) When Double slider specification (W) is selected, payload, dimensions and main unit mass will change. Refer to P. 10 and P. 12 for details.

Type	Cable code	T2		T4	
		Standard	With LS	Standard	With LS
Standard type	S (3m)	<input type="radio"/>	<input type="radio"/>	<input type="radio"/>	<input type="radio"/>
	M (5m)	<input type="radio"/>	<input type="radio"/>	<input type="radio"/>	<input type="radio"/>
Specified length	X06 (6m) ~ X10 (10m)	<input type="radio"/>	<input type="radio"/>	<input type="radio"/>	<input type="radio"/>
	X11 (11m) ~ X15 (15m)	<input type="radio"/>	<input type="radio"/>	<input type="radio"/>	<input type="radio"/>
	X16 (11m) ~ X20 (20m)	<input type="radio"/>	<input type="radio"/>	<input type="radio"/>	<input type="radio"/>

(Note) Robot cables are standard for this item.
 (Note) When using a cable longer than 20m up to 30m, specify "N" in the cable length of the actuator model, and separately order the cable. Model code for order is as follows.
 Specify the cable length in □□□. (Ex) 250=25m
 [Motor cable]
 T2 : CB-X-MA□□□
 T4 : CB-X2-MA□□□
 [Encoder cable]
 T2/T4 (Standard): CB-X1-PA□□□-AWG24
 T2/T4 (with LS): CB-X1-PLA□□□-WG24

Main specifications

Item		Details			
Lead	Ball screw lead (mm)	50	25		
Horizontal	Payload	Maximum payload (kg)(Note 3)	80	160	
		Maximum speed (mm/s)	2500	1250	
	Speed/acceleration/deceleration	Rated acceleration/deceleration (G)	0.3	0.3	
		Maximum acceleration/deceleration (G)	1.2	1.2	
Vertical	Payload	Maximum payload (kg)(Note 3)	14	32	
		Maximum speed (mm/s)	2500	1250	
	Speed/acceleration/deceleration	Rated acceleration/deceleration (G)	0.3	0.3	
		Maximum acceleration/deceleration (G)	1.0	0.6	
Thrust	Rated thrust (N)	255	510		
Brake	Brake specification	Non-excitation actuating solenoid brake			
	Brake holding force (kgf)	14	32		
Stroke	Min. stroke (mm)	900	900		
	Max. stroke (mm)	3000	3000		
	Stroke pitch (mm)	50	50		

(Note 3) When Double slider specification (W) is selected, the maximum payload will be decreased. Refer to the table below for details.

Item	Details
Driving system	Ball screw φ25mm, Rolled C10 [C5 equivalent]
Positioning repeatability	±0.01mm [±0.005mm]
Lost motion	0.05mm or less [0.02mm or less]
Base	Material: Aluminum white alumite treatment
Linear guide	Linear motion endlessly circulating type
Static allowable moment (Single slider specification)	Ma : 774 N·m
	Mb : 1106 N·m
	Mc : 2175 N·m
Static allowable moment (Double slider specification) (Note 4)	Ma : 3600 N·m
	Mb : 5270 N·m
	Mc : 4340 N·m
Dynamic allowable moment (Single slider specification) (Note 5)	Ma : 162 N·m
	Mb : 231 N·m
	Mc : 455 N·m
Dynamic allowable moment (Single slider specification) (Note 5)	Ma : Slider actual span Min. [35mm] 616 N·m, Max. [180mm] 1130 N·m
	Mb : Slider actual span Min. [35mm] 880 N·m, Max. [180mm] 1610 N·m
	Mc : Slider actual span Min. [35mm] 739 N·m, Max. [180mm] 739 N·m
Ambient operating temperature, humidity	0 - 40°C, 85%RH or less (Non-condensing)
Degree of protection	—
Vibration/shock resistance	4.9m/s ²
Overseas standards	CE marking, RoHS directive
Motor type	AC servo motor (200 V)
Encoder type	Incremental/battery-less absolute
Encoder pulse count	131072 pulse/rev

(Note 4) Values remain unchanged regardless of slider span.
 (Note 5) Based on the standard rated operational life of 10,000km. operational life varies according to operating and mounting conditions.
 (Note) Values in brackets [] are for ISPB.

Slider type moment direction

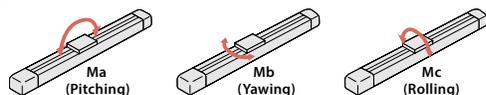

Payload by speed and acceleration

The unit for payload is kg. If blank, operation is not possible.

Orientation		Horizontal										Vertical									
Lead (mm)	Max. speed (mm/s)	Acceleration (G)										Acceleration (G)									
		0.2	0.3	0.4	0.5	0.6	0.7	0.8	0.9	1.0	1.1	1.2	0.2	0.3	0.4	0.5	0.6	0.7	0.8	0.9	1.0
50	2500	80	80	60	48	40	34	30	27	23	18	15	14	14	14	14	12	10	9	8	7
25	1250	160	160	120	96	80	68	60	54	46	36	30	32	32	32	26	21				

(Note) Operations may become unstable at low speed and with almost no payload.

Payload by speed and acceleration (Double slider specification)

The unit for payload is kg. If blank, operation is not possible.

Orientation		Horizontal										Vertical									
Lead (mm)	Max. speed (mm/s)	Acceleration (G)										Acceleration (G)									
		0.2	0.3	0.4	0.5	0.6	0.7	0.8	0.9	1.0	1.1	1.2	0.2	0.3	0.4	0.5	0.6	0.7	0.8	0.9	1.0
50	2500	70	70	50	38	30	24	20	17	14	8	5	10	10	8	6	4				
25	1250	150	150	110	86	70	58	50	44	36	26	20	25	25	22	20	19				

(Note) Operations may become unstable at low speed and with almost no payload.

Stroke and maximum speed

Stroke	900~3000 (every 50mm)
Lead	
50	2500
25	1250

(unit: mm/s)

Dimensions

(Note) The motor cable and encoder cable are to be connected to the cable joint connector. Refer to P. 18 for the details of the cable.
 (Note) When the slider is returning to its home position, be careful of interference from surrounding objects, as it will travel until it reaches the M.E.
 (Note) The product has to be sent back to IAI for adjustments when the home direction is changed.
 (Note) The external dimensions are the same as that of the product with brake.

CAD drawings can be downloaded from our website.
www.intelligentactuator.com



ST: Stroke
 M.E: Mechanical end
 S.E: Stroke end

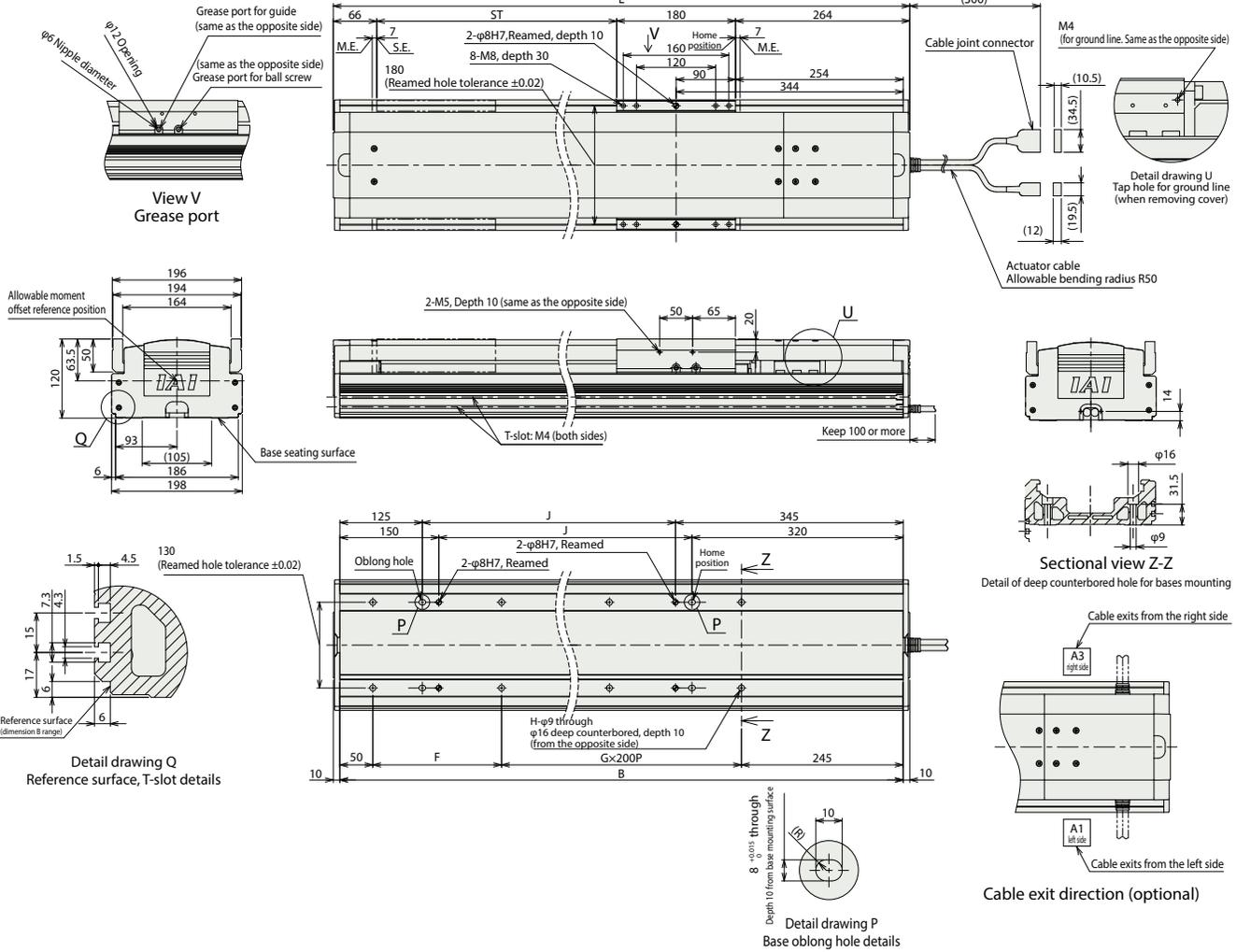

■ Dimensions by Stroke

Stroke	900	950	1000	1050	1100	1150	1200	1250	1300	1350	1400	1450	1500	1550	1600	1650	1700	1750	1800	1850	1900	1950
L	1410	1460	1510	1560	1610	1660	1710	1760	1810	1860	1910	1960	2010	2060	2110	2160	2210	2260	2310	2360	2410	2460
B	1390	1440	1490	1540	1590	1640	1690	1740	1790	1840	1890	1940	1990	2040	2090	2140	2190	2240	2290	2340	2390	2440
F	295	145	195	245	295	145	195	245	295	145	195	245	295	145	195	245	295	145	195	245	295	145
G	4	5	5	5	5	6	6	6	6	7	7	7	7	8	8	8	8	9	9	9	9	10
H	12	14	14	14	14	16	16	16	16	18	18	18	18	20	20	20	20	22	22	22	22	24
J	920	970	1020	1070	1120	1170	1220	1270	1320	1370	1420	1470	1520	1570	1620	1670	1720	1770	1820	1870	1920	1970

Stroke	2000	2050	2100	2150	2200	2250	2300	2350	2400	2450	2500	2550	2600	2650	2700	2750	2800	2850	2900	2950	3000
L	2510	2560	2610	2660	2710	2760	2810	2860	2910	2960	3010	3060	3110	3160	3210	3260	3310	3360	3410	3460	3510
B	2490	2540	2590	2640	2690	2740	2790	2840	2890	2940	2990	3040	3090	3140	3190	3240	3290	3340	3390	3440	3490
F	195	245	295	145	195	245	295	145	195	245	295	145	195	245	295	145	195	245	295	145	195
G	10	10	10	11	11	11	11	12	12	12	12	13	13	13	13	14	14	14	14	15	15
H	24	24	24	26	26	26	26	28	28	28	28	30	30	30	32	32	32	32	32	34	34
J	2020	2070	2120	2170	2220	2270	2320	2370	2420	2470	2520	2570	2620	2670	2720	2770	2820	2870	2920	2970	3020

■ Mass by Stroke

Stroke	900	950	1000	1050	1100	1150	1200	1250	1300	1350	1400	1450	1500	1550	1600	1650	1700	1750	1800	1850	1900	1950	
Mass (kg)	Without brake	38.4	39.5	40.5	41.6	42.7	43.7	44.8	45.8	46.9	48.0	49.0	50.1	51.2	52.2	54.2	55.3	56.4	57.4	58.5	59.6	60.6	61.7
	With brake	38.9	40.0	41.0	42.1	43.2	44.2	45.3	46.3	47.4	48.5	49.5	50.6	51.7	52.7	54.7	55.8	56.9	57.9	59.0	60.1	61.1	62.2

Stroke	2000	2050	2100	2150	2200	2250	2300	2350	2400	2450	2500	2550	2600	2650	2700	2750	2800	2850	2900	2950	3000	
Mass (kg)	Without brake	62.7	63.8	64.9	65.9	67.0	68.1	69.1	70.2	71.3	72.3	73.4	74.5	75.5	76.5	78.6	79.7	80.7	81.8	82.8	83.9	85.0
	With brake	63.2	64.3	65.4	66.4	67.5	68.6	69.6	70.7	71.8	72.8	73.9	75.0	76.0	77.0	78.0	79.1	80.2	81.2	82.3	83.3	84.4

Dimensions

(Note) The motor cable and encoder cable are to be connected to the cable joint connector. Refer to P. 18 for the details of the cable.
 (Note) When the slider is returning to its home position, be careful of interference from surrounding objects, as it will travel until it reaches the M.E.
 (Note) The product has to be sent back to IAI for adjustments when the home direction is changed.
 (Note) The external dimensions are the same as that of the product with brake
 (Note) The drawings below show dimension for the minimum slider actual span.

CAD drawings can be downloaded from our website.
www.intelligentactuator.com

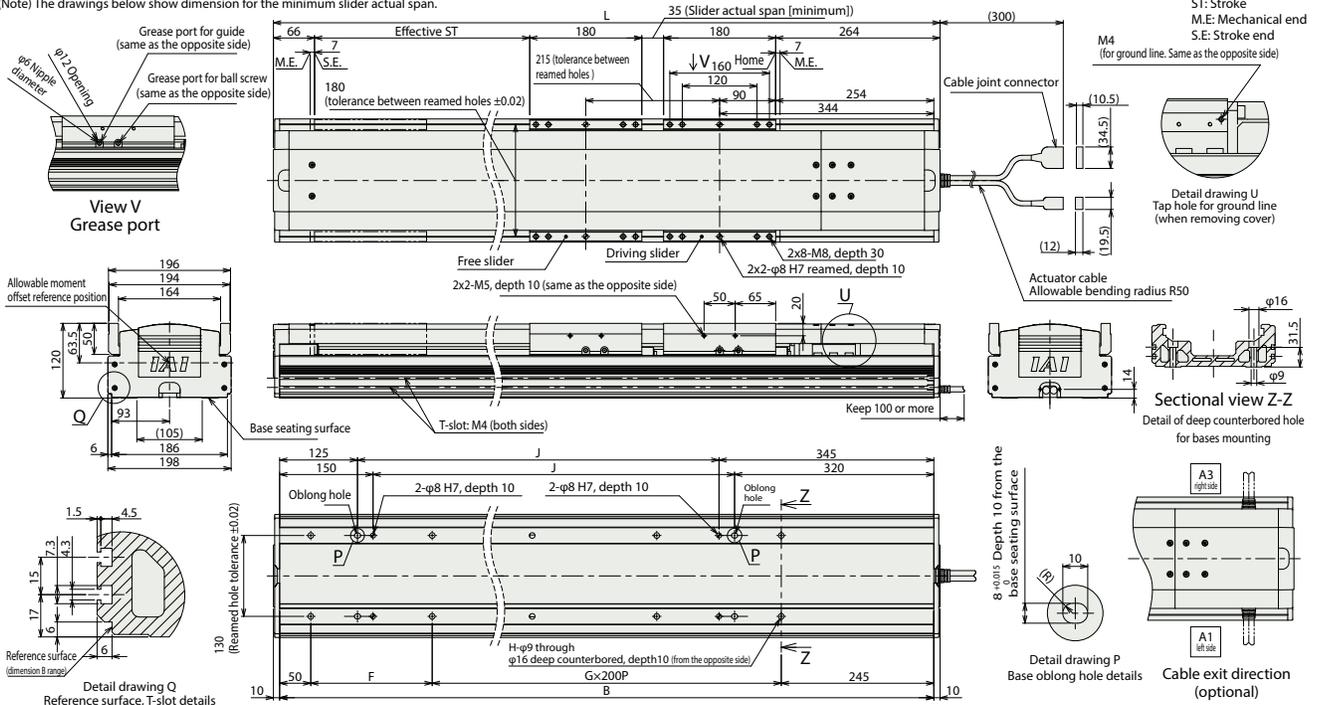

Dimensions by Stroke

	Nominal stroke	900	950	1000	1050	1100	1150	1200	1250	1300	1350	1400	1450	1500	1550	1600	1650	1700	1750	1800	1850	1900	1950
Effective stroke	Slider actual span minimum [35mm]	685	735	785	835	885	935	985	1035	1085	1135	1185	1235	1285	1335	1385	1435	1485	1535	1585	1635	1685	1735
	Slider actual span maximum [180mm]	540	590	640	690	740	790	840	890	940	990	1040	1090	1140	1190	1240	1290	1340	1390	1440	1490	1540	1590
	L	1410	1460	1510	1560	1610	1660	1710	1760	1810	1860	1910	1960	2010	2060	2110	2160	2210	2260	2310	2360	2410	2460
	B	1390	1440	1490	1540	1590	1640	1690	1740	1790	1840	1890	1940	1990	2040	2090	2140	2190	2240	2290	2340	2390	2440
	F	295	145	195	245	295	145	195	245	295	145	195	245	295	145	195	245	295	145	195	245	295	145
	G	4	5	5	5	5	6	6	6	6	7	7	7	7	8	8	8	8	9	9	9	9	10
	H	12	14	14	14	14	16	16	16	16	18	18	18	18	20	20	20	20	22	22	22	22	24
	J	920	970	1020	1070	1120	1170	1220	1270	1320	1370	1420	1470	1520	1570	1620	1670	1720	1770	1820	1870	1920	1970

	Nominal stroke	2000	2050	2100	2150	2200	2250	2300	2350	2400	2450	2500	2550	2600	2650	2700	2750	2800	2850	2900	2950	3000
Effective stroke	Slider actual span minimum [35mm]	1785	1835	1885	1935	1985	2035	2085	2135	2185	2235	2285	2335	2385	2435	2485	2535	2585	2635	2685	2735	2785
	Slider actual span maximum [180mm]	1640	1690	1740	1790	1840	1890	1940	1990	2040	2090	2140	2190	2240	2290	2340	2390	2440	2490	2540	2590	2640
	L	2510	2560	2610	2660	2710	2760	2810	2860	2910	2960	3010	3060	3110	3160	3210	3260	3310	3360	3410	3460	3510
	B	2490	2540	2590	2640	2690	2740	2790	2840	2890	2940	2990	3040	3090	3140	3190	3240	3290	3340	3390	3440	3490
	F	195	245	295	145	195	245	295	145	195	245	295	145	195	245	295	145	195	245	295	145	195
	G	10	10	10	11	11	11	11	12	12	12	12	13	13	13	13	14	14	14	14	15	15
	H	24	24	24	26	26	26	26	28	28	28	28	30	30	30	30	32	32	32	32	34	34
	J	2020	2070	2120	2170	2220	2270	2320	2370	2420	2470	2520	2570	2620	2670	2720	2770	2820	2870	2920	2970	3020

(Note) Nominal stroke: Stroke used as the model code. Effective stroke: Stroke actually operable.

Mass by Stroke

	Nominal stroke	900	950	1000	1050	1100	1150	1200	1250	1300	1350	1400	1450	1500	1550	1600	1650	1700	1750	1800	1850	1900	1950
Effective stroke	Slider actual span minimum [35mm]	685	735	785	835	885	935	985	1035	1085	1135	1185	1235	1285	1335	1385	1435	1485	1535	1585	1635	1685	1735
	Slider actual span maximum [180mm]	540	590	640	690	740	790	840	890	940	990	1040	1090	1140	1190	1240	1290	1340	1390	1440	1490	1540	1590
Mass (kg)	Without brake	41.4	42.5	43.5	44.6	45.7	46.7	47.8	48.8	49.9	51.0	52.0	53.1	54.2	55.2	57.2	58.3	59.4	60.4	61.5	62.6	63.6	64.7
	With brake	41.9	43.0	44.0	45.1	46.2	47.2	48.3	49.3	50.4	51.5	52.5	53.6	54.7	55.7	57.7	58.8	59.9	60.9	62.0	63.1	64.1	65.2

	Nominal stroke	2000	2050	2100	2150	2200	2250	2300	2350	2400	2450	2500	2550	2600	2650	2700	2750	2800	2850	2900	2950	3000
Effective stroke	Slider actual span minimum [35mm]	1785	1835	1885	1935	1985	2035	2085	2135	2185	2235	2285	2335	2385	2435	2485	2535	2585	2635	2685	2735	2785
	Slider actual span maximum [180mm]	1640	1690	1740	1790	1840	1890	1940	1990	2040	2090	2140	2190	2240	2290	2340	2390	2440	2490	2540	2590	2640
Mass (kg)	Without brake	65.7	66.8	67.9	68.9	70.0	71.1	72.1	73.2	74.3	75.3	76.4	77.5	79.5	80.5	81.6	82.7	83.7	84.8	85.8	86.9	88.0
	With brake	66.2	67.3	68.4	69.4	70.5	71.6	72.6	73.7	74.8	75.8	76.9	78.0	80.0	81.0	82.1	83.2	84.2	85.3	86.3	87.4	88.5

(Note) The free slider mass of 3kg is added to the single slider specification.

Applicable controllers

The actuator in this page can be operated by the following controllers. Select the type that suits the application of intended use.

Name	External appearance	Maximum number of connectable axes	Power voltage	Control method																Max. number of positioning points
				Positioner	Pulse train	Program	Network *Select													
							DV	CC	CIE	PR	CN	ML	ML3	EC	EP	PRT	SSN	ECM		
RCON		16 (8 for ML3, SSN and ECM)	DC24V Single phase AC200V Three-phase AC200V	-	-	-	●	●	●	●	-	-	●	●	●	●	●	●	128 (ML3, SSN and ECM have no positioning data)	
RSEL		8		-	-	●	●	●	●	●	-	-	-	-	●	●	-	-	36000	
SCON-CB/CGB		1	Single phase AC200V	●	●	-	●	●	●	●	●	●	●	●	●	●	-	●	512 (768 for the network specification)	
SSEL-CS		2		●	-	●	●	●	●	-	-	-	-	-	●	-	-	-	20000	
XSEL-P/Q		6	Single phase AC200V	-	-	●	●	●	●	●	-	-	-	-	●	-	-	-	20000	
XSEL-RA/SA		8	Three-phase AC200V	-	-	●	●	●	●	●	-	-	-	●	●	-	-	-	55000 (varies depending on the type)	

Options

Cable exit direction

Model A1 / A3

Description Specified when the actuator cable exit direction is changed.

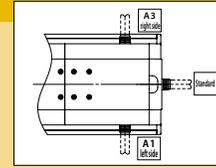

AQ seal

Model AQ (standard equipment)

Description AQ seal is a lubricant unit that uses a lubricating member made of lubricating oil solidified with resin. Because it is a porous member that contains a large amount of lubricating oil, the oil seeps out on the surface through capillary action. Lubricating oil is supplied by pressing the AQ seal on the surface of the guide and steel made ball screw, enabling long-term use without maintenance in a synergistic effect by the combined use of the grease.

Brake

Model B

Description This is a holding mechanism that prevents the slider from falling and damaging any attached fittings when the power or servo is turned off. This option is needed when the actuator is used vertically.

Hanging bracket

Model EB

Description For mounting the actuator, an eye bolt, mounting fittings, bolts with a hexagonal hole and hexagonal nuts are supplied to lift the actuator. The connecting nut to attach the mounting fittings is attached in the T slot of the main unit side surface for shipment.
* Check the operation manual for details.

Setting of high payload setting

Model HLA

Description This option increases payload capacity. In the case of the rated acceleration/deceleration (0.2G), the maximum payload is 400kg for horizontal operations and 80kg for vertical operations. (Note) Setting is available only for ISPB-WXM Lead 10.

Home limit switch

Model L

Description When performing home-return, the pressing method determines the home position upon pressing against the mechanical end and reversing. This is an option for triggering the reversion using the sensor. When L option is specified, 3 proximity sensors including HOME (for home detection), +OT (overtravel on opposite motor side) and -OT (overtravel on the motor side) will be installed. (HOME and -OT are integrated twin sensors) Use it to fine-tune the inverted position or enhance the certitude. (Please note that moving the home sensor excessively may shorten the stroke)
*The home limit switches, IS(P)B-WXM / WXXM, are installed inside the main unit.

Master axis specification/Slave axis specification in synchronous operation

Model LM(Limit master axis specification) S(Slave axis specified)

Description One of the features of the XSEL controller is "synchronous operation." This feature is used to operate the two axes of actuators at the same time. With one axis used as the master (M) and the other as the slave (S), the slave follows the master in ultra-high-speed control in order to operate at the same time. Two axes of actuators that run synchronously need to have the same specifications (type, lead, motor wattage and stroke). When performing a synchronous operation, the master axis needs to have the limit switch specification. Be sure to specify LM (limit specification master axis) for the option code of master axis and S for the slave axis.

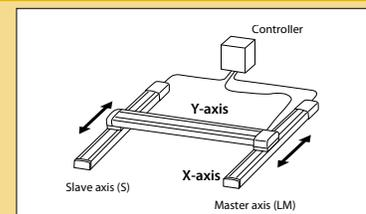

Non-motor end specification

Model NM

Description The normal home position is set to the motor side, but this is the option to set the home position on the other side in order to accommodate variations in equipment layout, etc. (Note that changing the home position after shipment may require the product to be sent back to IAI for re-setting.)

Double slider specification

Model W

Description This option is to add a free slider at the opposite side of the motor of the ball screw. Double slider increases allowable moment and overhang length. The driving and free sliders are not connected for shipment. The customer is required to connect them before use.

■ Precautions on the double slider specification

(1) Dynamic allowable moment and overhang length vary according to the span between two sliders.

<p>Dynamic allowable moment direction</p> <p>The dynamic allowable moment is a value that assumes the standard rated operational life. Beware that the operational life of the guide decreases if it is used exceeding the moment specification value.</p> <p>Moment directions</p>	<p>Overhang length</p> <p>If used in excess of allowable overhang value, vibration may occur. Make sure to use the product within the allowable value.</p>
<p>Double slider specification</p>	<p>Slider mounting drawing (image)</p> <p>The driving and free sliders are not connected for shipment. The customer is required to connect them before use. (Note) Make sure to connect the sliders with the span of 35 to 180mm.</p>

(2) Make sure to specify an effective stroke to order.

Ex) ISB-WXM-WA-750-50-1050-T2-M-AQ-W (effective stroke 800mm)

(3) When the double slider specification option is selected, the effective stroke (actually operable stroke) is the value obtained by subtracting (A) (Slider length+Slider actual span) from the nominal stroke (stroke used in the model code).

$$\text{Nominal stroke} \geq \text{Effective stroke} + (A)$$

(stroke used in model) (actually operable stroke)

Ex) IS(P)B-WXM
 Effective stroke: 800mm (A): 215mm (when the slider actual span is 35mm)
 800mm + 215mm = 1015mm ... Order the model of 1050mm.

Selectable effective stroke of the double slider specification (mm)	(A) slider length + slider actual span (mm)
100~1085(Nominal stroke 350~1300)	215
140~ 940(Nominal stroke 500~1300)	360
540~2785(Nominal stroke 900~3000)	215
540~2640(Nominal stroke 900~3000)	360

(4) Make sure to confirm the payload of the double slider specification, referring to the "Payload by Speed and Acceleration (Double slider specification)" on each product specification page.

(5) The maximum speed of the IS(P)B-WXM decreases as its stroke becomes longer due to the ball screw's dangerous number of revolution. Confirm the maximum speed of the desired nominal stroke, referring to the "Stroke and Max. Speed" of the product specification page.

■ Double slider specifications

Model	Dynamic allowable moment						Overhang length	Slider mass (kg)	Slider length (mm)	Selectable effective stroke of the double slider specification (mm)	(A) slider length + slider actual span (mm)	
	Standard rated operational life (km)	Slider span (mm)		Ma direction (N·m)	Mb direction (N·m)	Mc direction (N·m)						Ma·Mb·Mc direction
		Slider actual span	Slider cover span									
IS(P)B-WXM	10000	Min.35	—	616	880	739	1975	3.0	180	100~1085(Nominal stroke 350~1300)	215	
		Max.180	—	1130	1610	739	2700			140~ 940(Nominal stroke 500~1300)	360	
IS(P)B-WXMX	10000	Min.35	—	616	880	739	1975	3.0	180	540~2785(Nominal stroke 900~3000)	215	
		Max.180	—	1130	1610	739	2700			540~2640(Nominal stroke 900~3000)	360	

Duty ratio

When using IS(P)B-WXMX vertically, operate it at the duty ratio of 50% or less. In other cases, the guideline of the usable duty ratio varies depending on the operating conditions (such as payload and acceleration/deceleration). Calculate the load factor, LF, and time ratio of acceleration/deceleration t_{od} from the formula below.

Note:

If an over load error occurs, lower the duty ratio by extending the stop time or slow down acceleration/deceleration.

Calculation method of the duty ratio

Calculate the load factor and acceleration/deceleration time ratio, and read the duty ratio from the graph. When the load factor is less than 50%, the duty ratio of 100% (continuous operation) is possible.

[Duty ratio]

The duty ratio is the operation rate in % of the time the actuator is operating in one cycle.

$$D = \frac{T_M}{T_M + T_R} \times 100(\%)$$

D : duty ratio
 T_M : Motion time (including push motion)
 T_R : Stop time

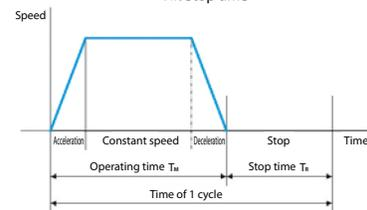

1 Load factor LF

Refer to the product specification page for the rated acceleration/deceleration and maximum payload at the rated acceleration/deceleration.

When the acceleration/deceleration is smaller than the rated value during operation

$$\text{Load factor : LF} = \frac{M \times \alpha}{M_r \times \alpha_r} (\%)$$

Maximum payload at the rated acceleration : M_r (kg)
 Rated acceleration/deceleration : α_r (kg)
 Payload during operation : M (kg)
 Acceleration/deceleration during operation : α (G)

When the acceleration/deceleration is greater than the rated value during operation

$$\text{Load factor : LF} = \frac{M \times \alpha}{M_d \times \alpha} = \frac{M}{M_d} (\%)$$

Payload of command acceleration : M_d (kg)
 Payload during operation : M (kg)
 Acceleration/deceleration during operation : α (G)

2 Acceleration/deceleration time ratio t_{od}

$$\text{Acceleration/deceleration time ratio } t_{od} = \frac{\text{Acceleration time during operation} + \text{deceleration time during operation}}{\text{Operation time}} (\%)$$

$$\text{Acceleration time} = \frac{\text{Operating speed (mm/s)}}{\text{Operating acceleration (mm/s}^2)} \text{ (sec.)} \quad \text{Deceleration time} = \frac{\text{Operating speed (mm/s)}}{\text{Operating deceleration (mm/s}^2)} \text{ (sec.)}$$

$$\text{Acceleration (mm/s}^2) = \text{Acceleration (G)} \times 9800 \text{ mm/s}^2 \quad \text{Deceleration (mm/s}^2) = \text{Deceleration (G)} \times 9800 \text{ mm/s}^2$$

3 Reading the duty ratio from the calculated load factor LF and Acceleration/deceleration time ratio t_{od}

Ex) When the load factor LF is 80% and Acceleration/deceleration time ratio t_{od} is 80%, the guideline of the duty ratio is approx. 75%.

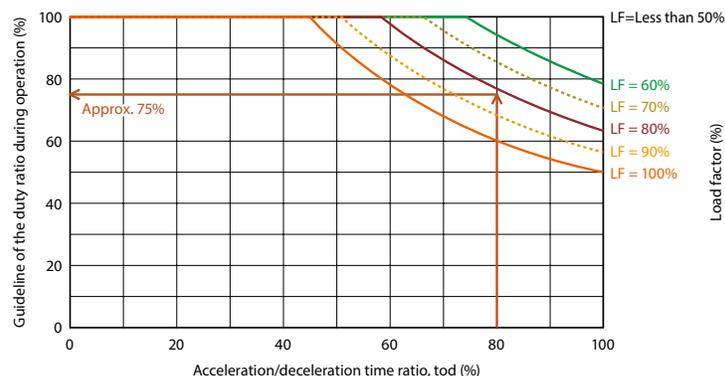

Maintenance parts (actuator)

■ IS(P)B-WXM / WXM Maintenance parts schematic drawing

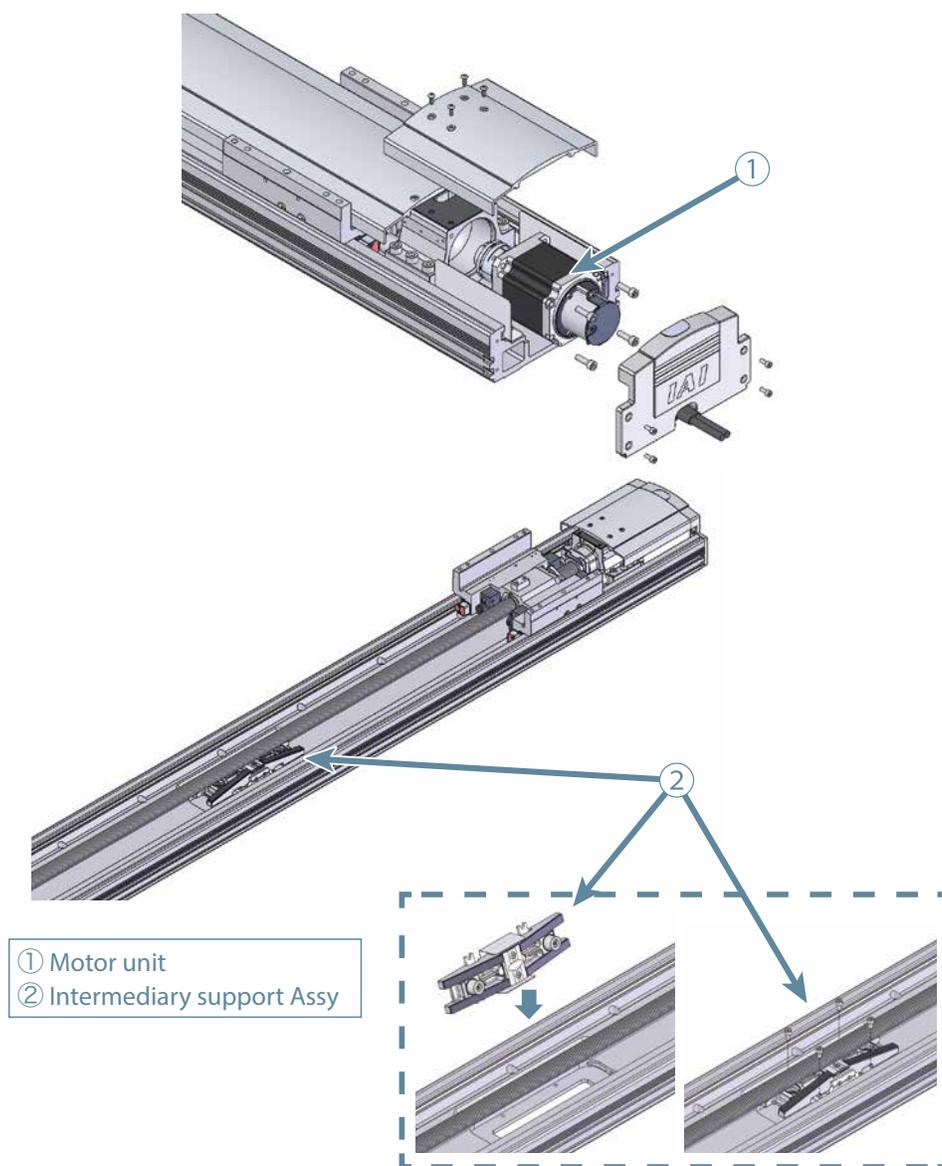

■ List of maintenance parts model codes

The numbers in the list correspond to those in the schematic drawing.

Main unit model	① Motor unit	
	Without brake	With brake
WXM / WXM	M-ISB-TMA750-WA-CO	M-ISB-TMA750-WA-BT-CO

Main unit model	② Intermediary support Assy	Required quantity	
		Stroke (mm)	Quantity (pieces)
WXM	IMS-ISB-WXM	900 ~ 1550	1
		1600 ~ 2550	2
		2600 ~ 3000	3

Controller/Options



Refer to the IAI General Catalog 2021, Volume 8 for the details of the controllers and options.

If you are considering RCON/RSEL, the "R-unit Controller Model Selection System" is recommendable.

Single axis controller

In case of a single axis control using one controller

Supported control method

PIO (input/output)
Pulse train
Field network
Serial communication (Modbus)

SCON



SCON supports pulse output. Easy links with related control devices is possible.

(When a field network control with pulse output is necessary, contact IAI representatives)

- Low price
- The same control mode as a solenoid valve is possible
- Controller dedicated programs are not necessary

200v AC servo motor

Multi-axis controllers

Control of multiple axes by a single controller

Supported control method

SEL Language (IAI special program)
PIO (input/output)
Field network

RCON



24v Pulse motor, 24v AC servo motor, 24v DC brushless motor, 200v AC servo motor

- Compact
- Low price
- Connectable up to 16 axes
(There are some limitations depending on the operating mode.)

RSEL



24v Pulse motor, 24v AC servo motor, 24v DC brushless motor, 200v AC servo motor

- Compact
- Low price
- Connectable up to 16 axes

SSEL



200v AC servo motor

- Interpolation is possible up to 2 axes

XSEL



200v AC servo motor

- Synchronizing control of 2 axes is possible
- Interpolation is possible up to 8 axes

Use these controllers when interpolation motions are required.

PC-compatible teaching software

There are two kinds of software to set up positions and parameters. Please purchase through your distributor and a download link will be sent to your valid email address.



IA-OS

Supports controllers whose model code has "□CON"



IA-101-□

Supports controllers whose model code has "□SEL"

Teaching pendant



TB-02



TB-03

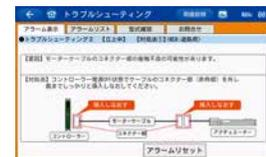

- Equipped with a full-color touch panel
- Position data registration, trial run, troubleshooting for errors and display of the maintenance list are possible.

Maintenance parts (cable)

When ordering maintenance parts such as a cable after your purchase of an actuator, refer to the following model codes.

Table of compatible cables

* Specify cable length (L) in □□□. Ex) 080=8m

	Cable length (m)	Motor robot cable		Encoder robot cable
		SCON / SSEL / XSEL	RCON / RSEL	Common to all controllers
IS(P)B Standard	1 ~ 20	CB-X-MA □□□□	CB-X2-MA □□□□	CB-X1-PA □□□□
	21 ~ 30			CB-X1-PA □□□□ -AWG24
IS(P)B with LS	1 ~ 20			CB-X1-PLA □□□□
	21 ~ 30			CB-X1-PLA □□□□ -AWG24

Model **CB-X-MA** □□□□

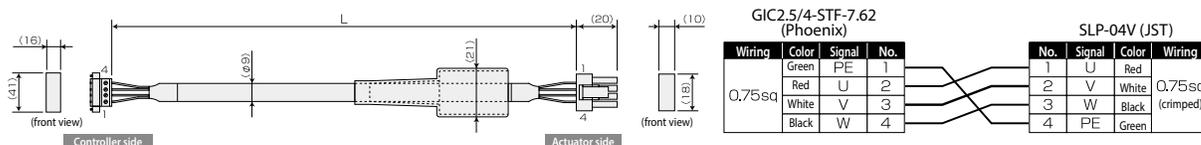

Minimum bending R r=51mm or more (dynamic bending condition)

Model **CB-X2-MA** □□□□

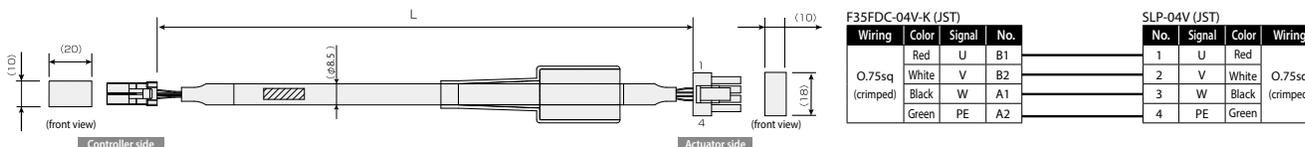

Minimum bending R r=51mm or more (dynamic bending condition)

Model **CB-X1-PA** □□□□ / **CB-X1-PA** □□□□ -AWG24

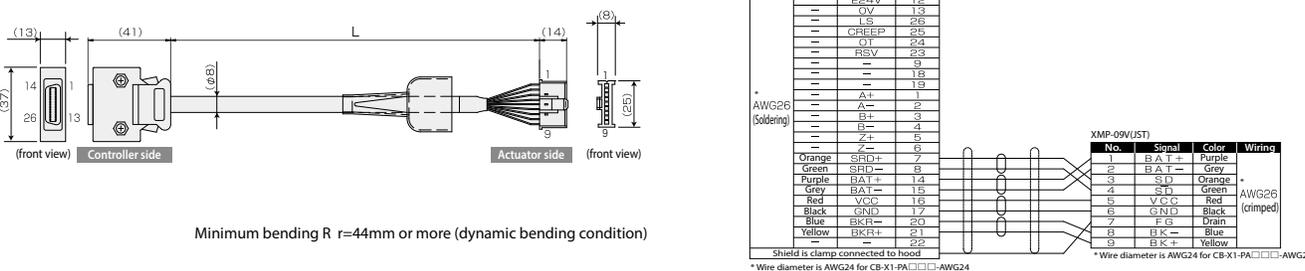

Minimum bending R r=44mm or more (dynamic bending condition)

Model **CB-X1-PLA** □□□□ / **CB-X1-PLA** □□□□ -AWG24

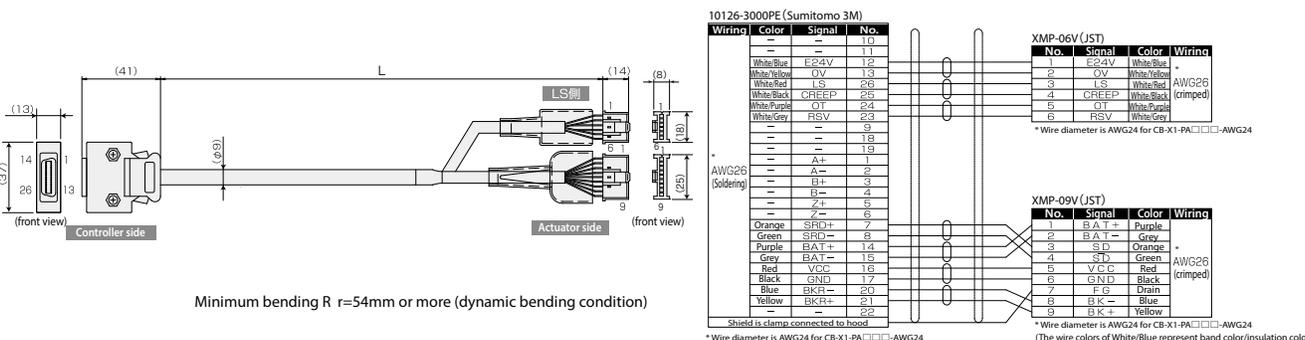

IAI America, Inc.

USA Headquarter & Western Region (Los Angeles): 2690 W. 237th Street, Torrance, CA 90505 (800) 736-1712

Midwest Branch Office (Chicago) : 110 E. State Pkwy, Schaumburg, IL 60173 (800) 944-0333

Southeast Branch Office (Atlanta): 1220 Kennestone Circle, Suite 108, Marietta, GA 30066 (678) 354-9470

www.intelligentactuator.com

JAPAN Headquarters: 577-1 Obane, Shimizu-ku, Shizuoka-shi, Shizuoka, 424-0103, JAPAN

The information contained in this product brochure may change without prior notice due to product improvements.

IAI Industrieroboter GmbH

Ober der Röth 4, D-65824 Schwalbach am Taunus, Germany

IAI (Shanghai) Co., Ltd.

Shanghai Jiahua Business Center A8-303, 808,
Hongqiao Rd., Shanghai 200030, China

IAI Robot (Thailand) Co., Ltd.

825 Phairojkijja Tower 7th Floor, Debaratana Rd.,
Bangna Nuea, Bangna, Bangkok 10260, Thailand